



PRECISION WEEDING

FELCROP

Price List 022

Effective from  
1<sup>st</sup> September 2022

by  
**ERM/AS**

Net price in €  
excluding tax  
ex factory

These General Conditions of Sale are drawn up for the 2023 Season and are applicable as from 1st July 2022. Should the legislation change (law, order, decree, industry agreement, etc.), ERMAS company reserves the right to modify its General Conditions of Sale accordingly.

## 1. General Principles :

- 1-1. The General Conditions of Sale apply only to the dealers or retailers normally ensuring the essential services: assembly, delivery, starting up of new equipment, spare parts storage, after-sales service, repairing and possible taking back of used machines.
- 1-2. The absence of services leads to the reduction of the discount rate, according to our distribution policy and accreditation conditions without, for all that, engaging the liability of ERMAS company, which shall not in any event be required to provide these services itself. This reduction is also applied to the sales made after testing, demonstration or start-up performed by the factory's technical department.
- 1-3. In order to be considered, each buying group shall send us, at the beginning of the season, a complete list of its members as well as the address of the body centralizing orders, payments and possibly deliveries. In the event of payment problems with a member directly invoiced, ERMAS company would immediately alert the group's managers and would take all measures it deems fitting to recover its debt.
- 1-4. EVERY ORDER PLACEMENT IMPLIES UNRESERVED ACCEPTANCE OF OUR GENERAL CONDITIONS OF SALE AND OF PAYMENT FOR THE CURRENT SEASON and renders null and void any different or contradictory wording featuring on the buyer's order form. The buyer accepts the application of these Conditions of Sale. The parties agree that these Conditions of Sale prevail over all of the buyer's purchase conditions.
- 1-5. The Price List is drawn up ex-works. Under no circumstances will ERMAS company bear the costs linked to transportation, assembly and availability, unless specifically agreed and against a corresponding invoice for costs incurred.

## 2. Orders

- 2-1. Very large orders could be partially accepted and spread over the entire season.
- 2-2. Any order change should be sent to us at least **6 weeks** before the scheduled delivery date.
- 2-3. **A deposit payment corresponding to 20 % of the crop price will be requested with the order for :**
  - special machines having formed the subject of an estimate,
  - new customers and customers from whom ERMAS company requires a payment before shipment.
- 2-4. The price list is guaranteed if delivery takes place within 30 days of the date of order. After this 30-day period, the price invoiced will be the price in effect on the day of shipment or the day when the machine is made available.
- 2-5. The basic discount rate is due on invoice. Some additional discounts granted throughout the season will be paid only at the end of the season, according to our terms and conditions and after full payment of invoices due to ERMAS company.
- 2-6. All the accessories and related equipment benefit from the same conditions and discounts as the machines. Parts will be subjected to special conditions.

## 3. Availability - Delivery

- 3-1. Delays in availability due to events of force majeure or for any reason beyond our control will mean automatic adjustment of any advantages granted. The same shall apply for delays in collection at the factory by the customer or for requested delivery postponement. The delivery time indicated, at the start of the season, at the time of ordering, is only an estimated delivery time due to factors may have an impact on production and may be revised, the distributor being informed.  
ERMAS company undertakes to guarantee the availability period with tolerance of more or less 2 weeks.  
if the machine is made available within the delivery time of more or less 2 weeks, the buyer may not claim any compensation for delay in availability.  
Where transport is organized by ERMAS company, the delivery time will be added to the schedule for availability.  
Delivery times are only estimates; no penalty may be claimed for delays in delivery.

### TRANSPORTS PRICE :

Depending on the weight

## 4. Payment conditions

- 4-1. Invoices can be paid by bank transfer, cheque or bill of exchange.
- 4-2. In the event of late payment, the customer will be required to pay late payment interest to ERMAS company equal to 3 times the statutory interest rate, along with the total of the fixed compensation for recovery costs established by decree at 40 Euros per invoice. This late payment interest and this fixed compensation are due without any reminder being necessary.  
The late payment interest and the penalty are calculated on the basis of the final value inclusive of VAT shown on the invoice.

### CONDITIONS DE PAIEMENT : ESCOMPTE d'AVANT SAISON (applicable sur le Net Hors TVA)

POUR COMMANDE + PAIEMENT AVANT SAISON	
15 October :	6%
31 October :	5,50%
15 November :	5%
30 November :	4,50%
15 December :	4%
31 Decembr :	3,50%
15 January :	3%
31 January :	2,50%
15 February :	2%
28 February :	1,50%

All orders must be placed at least 1 week in advance before the date of payment, and the transfer made before the maximum date of payment to benefit from the discount corresponding (see table above).

## 5. Returns

Our machines, accessories or spare parts can only be returned or exchanged on a completely exceptional basis, during the season of their sale and only after agreement given by ERMAS company. By default, a systematic deduction of 10% on the gross price will be applied for all returns of parts or accessories (except in the case of a mistake made by us).

## 6. Warranty

- 6-1. Our warranty includes the replacement of parts recognized as defective (excluding replacement parts). In no event may we be held liable in the case of misuse or non-verification of the correction functioning of the machine as a whole at the time of start-up and during the season. Retailers or users may not claim any compensation from us for possible loss they might sustain (labour or carriage charges, faulty operation, material or physical accidents, loss of profit on harvest, etc.).
- 6-2. Any part subject to a warranty claim should be sent to us using a prepaid method and accompanied by the warranty claim form to the company ERMAS for analysis. An exchange or a repair will be organized or a Credit Note issued if the warranty claim is accepted. Disassembly and reassembly will be payable by the distributor as part of normal service. Unilateral reduction of prices by the customer is not possible.

## 7. Retention of title

All our sales are made with retention of title. In the case of full or partial non-payment of the price on the due date, for an amount with is not insignificant, the company ERMAS will have the right to repossess its goods, without formality, at the buyer's own expense and risk. Notwithstanding this retention of title clause, all risks are incumbent on the buyer from delivery of the equipment.

## 8. Use of the MONOSEM trademark

**No customer of ERMAS company may indicate or use** the trademarks or logos of ERMAS company and/or its affiliated companies without the express prior written consent of ERMAS company and this, for the sole purpose of promoting resale of the products sold by ERMAS company under the normal conditions of its activity.

## 9. Jurisdiction

The contract is subject to French law. In case of dispute between ERMAS company and the customer, the only courts with jurisdiction are those of SENS (FRANCE) unless ERMAS company prefers to refer any dispute to any other court with jurisdiction.



# Summary

Rotative weeder TARGA	4/5
Tined weeder SIGMA	6/7
Rotary finger weeders on frame	8
Rotary finger weeders on element	9
Rotary finger weeder spare parts	10/11
Special equipments	12
Ridger discs	13
Rotative weeder	14
Weeder tines	15
Special tines	16
Tines spare parts	17
Crop protection	18
Precut disks	19
Vegetable interface for camera guidance	20
Arable farming interface for camera guidance	21
3D camera / row feelers guidance	22
Colorimetric camera / row feelers guidance	23
Hydraulic elements lift with switch box	24
ISO hydraulic elements lift	25
DPAE electric drive	26





## + ADVANTAGES

- High aggressivity due to its heavy frame
- Hitch : CAT 3
- Transport width : 3,50 m
- Optimal ground following: 1.50 m section and independent rotors
- Pressure adjustment from the tractor (0 to 25 kg / rotor)
- Working width / rotor : 15 cm
- Adjustable working height with depth control wheel
- High clearance under frame : 65 cm
- Double central rotors with manual pressure adjustment as standard.

## PRICE

Designation	Ref.	Price / €
Rotative weeder 6 m	TARGA6M	<b>17 717 €</b>
Rotative weeder 12 m	TARGA12M	<b>34 491 €</b>



 With 12 m rotative weeder : possibility to use in 6 m working width





**+ OUR STRENGTHS**

Continuous hydraulic pressure adjustment



High flex rotor



Central overlapping rotors (as standard)

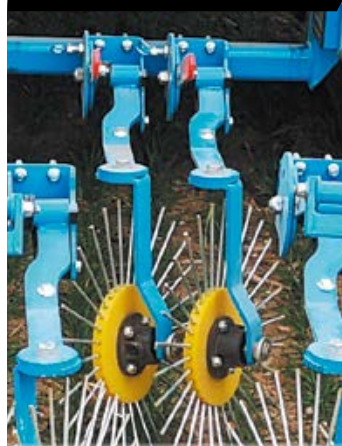

18x8.5 R8 wheel with agricultural profile



**CHARACTERISTICS**

Working width	Section number	Wheel number	Rotor number	Weight	Folding mode	Hitch category	Distributor number
<b>6 m</b>	4 x 1,5	4	40	1,800 T	Vertical - 3 parts	CAT 3	3
<b>12 m</b>	8 x 1,5	6	80	2,400 T	Wallet - 5 parts	CAT 3	3





## + ADVANTAGES

- > Early to late intervention thanks to adjustable working pressure
- > High clearance under the frame
- > Versatile tine for a wide range of crops
- > Large pressure adjustment range from 500 g to 5 kg
- > Continuous hydraulic adjustment with indicator
- > 6 tine rows
- > 25 mm tine spacing
- > Ø 7 mm independent tine
- > 3-point oblong holes for terrain following on hilly ground
- > Pivoting rear wheels
- > Pin adjustment of the wheels
- > Large diameter wheels with agricultural profile
- > Unhitching stand for storage in folded position
- > Road signs as standard

## PRICE

Designation	Ref	Price / €
6 m tined weeder	SIGMA6M	<b>16 330 €</b>
9 m tined weeder	SIGMA9M	<b>20 041 €</b>
12 m tined weeder	SIGMA2M	<b>31 918 €</b>



## CHARACTERISTICS

Working width	Compartments	Wheel number	Tine number	Weight	Folding mode	Hitch category	Distributor number
<b>6 m</b>	3	8	240	1,300 T	Vertical - 3 parts	CAT 2	3
<b>9 m</b>	3	8	360	1,800 T	Vertical - 3 parts	CAT 3	3
<b>12 m</b>	5	12	480	2,200 T	Wallet - 5 parts	CAT 3	3





**+ OUR STRENGTHS**

**Continuous hydraulic pressure adjustment**



**Pivoting rear wheels**



**Stands for unhitching in folded position**



**Strong 18x8.5 R8 tyres with agricultural profile**



**Independent pressure tines**





Cultivator frame mounting with  $\varnothing 250$  mm,  $\varnothing 290$  mm et  $\varnothing 370$  mm rotors

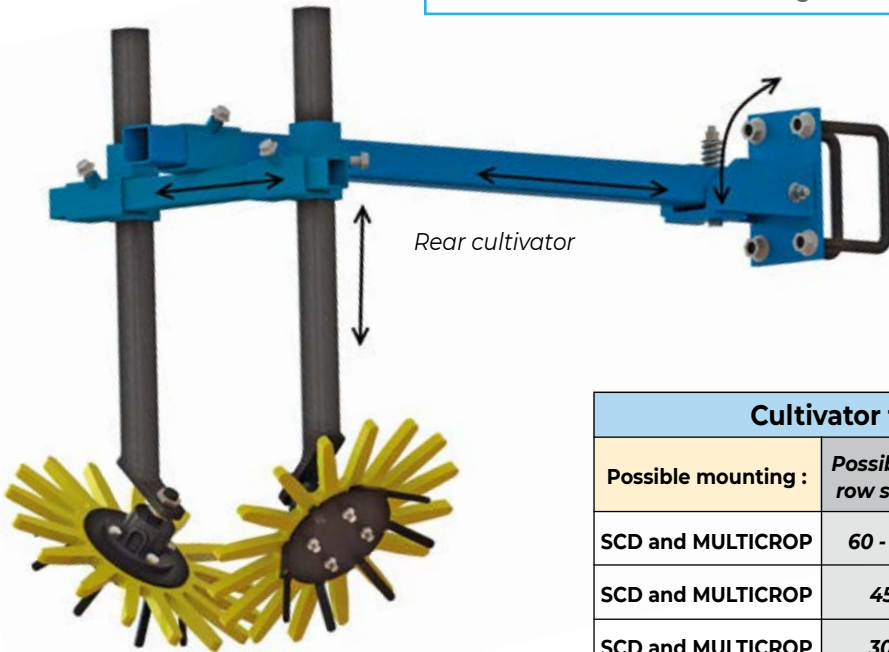

Rear cultivator

### CHARACTERISTICS ROTORS



soft

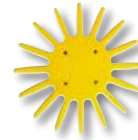

medium

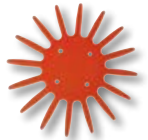

hard

### Cultivator frame mounting : Rear cultivator

Possible mounting :	Possible inter-row spacings	Designation	Part Ref	Price € / SET
SCD and MULTICROP	60 - 75 - 80	Rotors $\varnothing 370$ mm*	MOMB37C	622 € / SET
SCD and MULTICROP	45 - 50	Rotors $\varnothing 290$ mm*	MOMB29C	619 € / SET
SCD and MULTICROP	30 - 40	Rotors $\varnothing 250$ mm*	MOMB25C	626 € / SET
	Pair of off-set supports (Mandatory on folding cultivator)	MOMB033	71,88 € / pair	

\* Yellow rotor supplied in standard = medium hardness.



Mounting not compatible with Section Control : prefer mounting on element

### Options : Rear cultivator

Designation	Part Ref	Price €
Super Prefer adaptator	MOMB007	40,76 € / SET
120x120 beam kit	MOMB017	7,41 € / SET



Rear cultivator

### Cultivator frame mounting : FRONT CULTIVATOR

Possible mounting :	Possible inter-row spacings	Designation	Part Ref	Price € / SET
SCD and MULTICROP	45 - 50 60 - 75 - 80	Rotors $\varnothing 290$ mm*	MOMB29CF	628 € / SET
SCD and MULTICROP	25 - 40	Rotors $\varnothing 250$ mm*	MOMB25CF	639 € / SET
	Pair of off-set supports special front (Mandatory on folding cultivator)	MOMB026	85,96 € / pair	

\* Yellow rotor supplied in standard = medium hardness.

(For front cultivator with reversed unit)

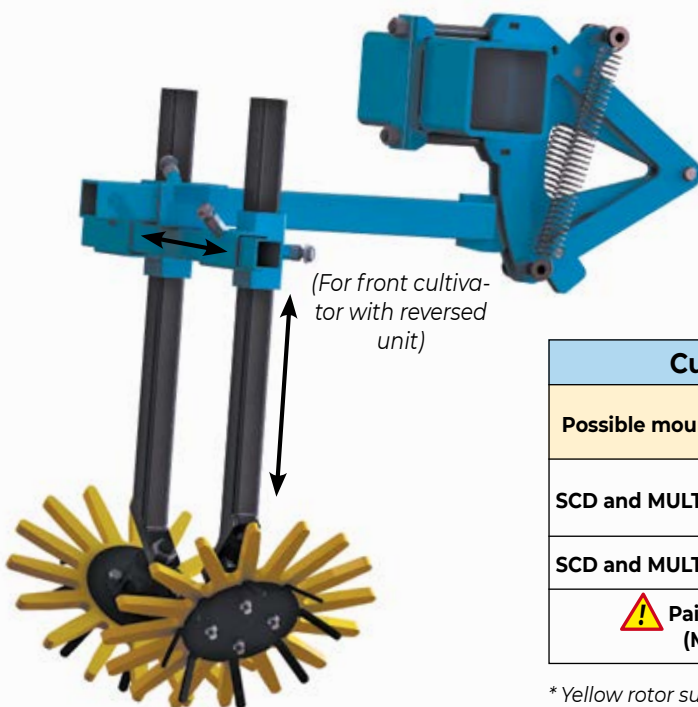

**EXAMPLE:** 6 row corn cultivator, hydraulic folding, rear mounting 75 cm = 6 x MOMB37C + 1 x MOMB033



Mounting on element with  $\varnothing 250$  mm,  $\varnothing 290$  mm et  $\varnothing 370$  mm rotors

## $\varnothing 250$ mm ROTOR



Mounting on element with $\varnothing 250$ mm rotor				
Possible mounting :	Advised inter-row spacing	Designation	Part Ref	Price € / SET
SCD	25 - 40	$\varnothing 250$ mm* Yellow rotor finger weeder on element (Central elements)	MOMB25ES	569 € / SET
SCD	25 - 40	$\varnothing 250$ mm* Yellow rotor finger weeder on element (Pair of side elements)	MOMB25ELS	694 € / SET
MULTICROP	25 - 40	$\varnothing 250$ mm* Yellow rotor finger weeder on element (Central elements)	MOMB25E	565 € / SET
MULTICROP	25 - 40	$\varnothing 250$ mm* Yellow rotor finger weeder on element (Pair of side elements)	MOMB25EL	687 € / SET

## $\varnothing 290$ mm ROTOR



Mounting on element with $\varnothing 290$ mm rotor				
Possible mounting :	Advised inter-row spacing	Designation	Part Ref	Price € / SET
SCD	45/50	$\varnothing 290$ mm* Yellow rotor finger weeder on element (Central elements)	MOMB29ES	557 € / SET
SCD	45/50	$\varnothing 290$ mm* Yellow rotor finger weeder on element (Pair of side elements)	MOMB29ELS	682 € / SET
MULTICROP	45/50	$\varnothing 290$ mm* Yellow rotor finger weeder on element (Central elements)	MOMB29E	553 € / SET
MULTICROP	45/50	$\varnothing 290$ mm* Yellow rotor finger weeder on element (Pair of side elements)	MOMB29EL	674 € / SET

## $\varnothing 370$ mm ROTOR



Mounting on element with $\varnothing 370$ mm rotor				
Possible mounting :	Advised inter-row spacing	Designation	Part Ref	Price € / SET
MULTICROP	60	$\varnothing 370$ mm* Yellow rotor finger weeder on element (Central elements)	MOMB37ED	639 € / SET
MULTICROP	60	$\varnothing 370$ mm* Yellow rotor finger weeder on element (Pair of side elements)	MOMB37ELD	761 € / SET
MULTICROP	75/80	$\varnothing 370$ mm* Yellow rotor finger weeder on element (Central elements)	MOMB37E	641 € / SET
MULTICROP	75/80	$\varnothing 370$ mm* Yellow rotor finger weeder on element (Pair of side elements)	MOMB37EL	762 € / SET

\* Yellow rotor supplied in standard = medium hardness.



















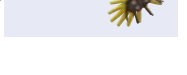
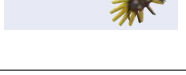

 Tools bracket included

**EXAMPLE:** 6 row corn cultivator, hydraulic folding, rear mounting 75 cm = 5 x MOMB37E + 1 x MOMB37EL

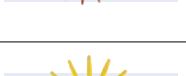



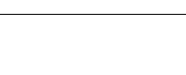



















## Rotary finger weeder spare parts

Designation	Ref. piece	Price €	
Flexible arm + mounting accessories	MOMB059	196,37 €	
Tools bracket for MULTICROP	MOZ005	121,52 €	
Tools bracket for SCD	MOZ006	124,49 €	
Rear off-set	MOMB058	28,90 €	
Cross part (Support beam) - 40 x 40 / Lg 500	MOZ004	45,20 €	
Half cross part (Half support beam) - 40 x 40 / Lg 280	MOZ003	35,57 €	
Right connecting sleeve - 50 x 50	MOZ001	22,23 €	
Left connecting sleeve - 50 x 50	MOZ002	22,23 €	
Complete leg Ø 250 mm yellow	MOMB031	157,83 €	
Complete leg Ø 290 mm yellow	MOMB060	151,91 €	
Complete leg Ø 370 mm yellow	MOMB061	177,84 €	
Ø 250 mm orange rotor	MOMB034	52,61 €	
Ø 250 mm yellow rotor	MOMB035	52,61 €	
Ø 250 mm red rotor	MOMB036	52,61 €	
Ø 290 mm orange rotor	MOMB032	46,68 €	
Ø 290 mm yellow rotor	MOMB030	46,68 €	
Ø 290 mm red rotor	MOMB062	46,68 €	
Ø 370 mm orange rotor	MOMB027	52,61 €	
Ø 370 mm yellow rotor	MOMB006	52,61 €	
Ø 370 mm red rotor	MOMB028	52,61 €	
Rolling + nuts	MOZ009	51,87 €	
Rotor Ø 340 wire rotor (special beans)	MOMB048	37,79 €	



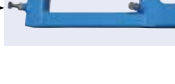

Rotary finger weeder spare parts

Designation	Ref. piece	Price €	
32 x 10 flexible bracket + accessories	MOZ040	48,17 €	
40 x 12 flexible bracket + accessories	MOZ041	48,17 €	
Complete leg flat bar Ø 250 mm yellow	MOMB037	140,05 €	
Complete leg flat bar Ø 290 mm yellow	MOMB038	152,65 €	
Complete leg flat bar Ø 370 mm yellow	MOMB039	157,83 €	
Ø 250 mm drive unit	MOMB012	20,75 €	
Ø 290 mm drive unit	MOMB013	25,19 €	
Ø 370 mm drive unit	MOMB014	31,86 €	
Half crossbar (flat bar) 50 x 12 / Lg 140 mm	MOMB025	28,16 €	
Half crossbar (flat bar) 50 x 12 / Lg 300 mm	MOMB040	34,09 €	
Half crossbar (flat bar) 50 x 12 / Lg 450 mm	MOMB041	42,24 €	
Extended half crossbar (flat bar) 50 x 12 / Lg 140 mm	MOMB024	32,60 €	
Sleeve 60 x 60 for flexible bracket	MOZ042	27,42 €	
Half cross part - 50 x 50 / Lg 280 mm	MOMB045	35,57 €	
Half cross part - 50 x 50 / Lg 365 mm	MOMB044	37,79 €	
Cross part -50 x 50 / Lg 650 mm	MOMB043	51,13 €	
90° connecting sleeve	MOHE002	22,97 €	
90° double connecting sleeve	MODB001	42,98 €	
1/4 rotary finger weeder Ø540 mm yellow	MOMB042	85,22 €	
1/4 rotary finger weeder Ø540 mm red	MOMB046	101,52 €	
1/4 rotary finger weeder Ø700 mm red	MOMB047	168,21 €	



Arboriculture, Viticulture, Aromaticplant

## BEANS ROTARY WEEDER

Special beans				
Possible mounting :	Advised inter-row spacing	Designation	Part Ref	Price €
MULTICROP / SCD	37,5 à 80	Complete leg special beans	MOMB059	143 € / piece

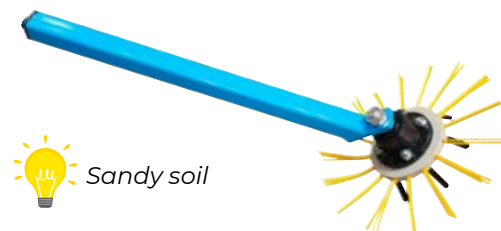

## LAMES BATHELIERS FOR LAVENDER

Lames Batheliers for lavender				
Possible mounting :	Advised inter-row spacing	Designation	Part Ref	Price €
MULTICROP	180	Lames Batelier for lavender	MOLB1	536 € / piece



## Ø 370 mm rotary finger weeder with adjustable leg

Ø 370 mm rotary finger weeder				
Possible mounting :	Advised inter-row spacing	Designation	Part Ref	Price €
For flexible arm on frame	90 - 180	Adjustable leg Ø 370 mm Red	MOMB029	263,80 € / piece



## Ø 540 mm rotary finger weeder with adjustable leg

Ø 540 mm rotary finger weeder				
Possible mounting :	Advised inter-row spacing	Designation	Part Ref	Price €
To adapt	—	Adjustable leg Ø 540 mm Yellow	MOMB54J	828 € / piece
To adapt	—	Adjustable leg Ø 540 mm Red	MOMB54R	876 € / piece



## Ø 700 mm rotary finger weeder with adjustable leg

Ø 700 mm rotary finger weeder				
Possible mounting :	Advised inter-row spacing	Designation	Part Ref	Price €
To adapt	—	Adjustable leg Ø 700 mm Red	MOMB70R	1180 € / piece





Element mounting with  $\varnothing 300$  mm,  $\varnothing 350$  mm and  $\varnothing 400$  mm discs

## DISCS $\varnothing 300$ mm



## DISCS $\varnothing 350$ mm



## DISCS $\varnothing 400$ mm



**EXAMPLE:** 6 row corn cultivator, hydraulic folding, rear mounting 75 cm = 5 x MODB30 + 1 x MODB30L

### Element mounting with $\varnothing 300$ mm discs

Possible mounting :	Possible inter-row spacings	Designation	Part Ref	Price € / SET
MULTICROP (Offset mounting)	45/50	$\varnothing 300$ mm ridger discs (Central elements)	MODB30T	537 € / SET
MULTICROP (Offset mounting)	45/50	$\varnothing 300$ mm ridger discs (Pair of side elements)	MODB30TL	648 € / SET
MULTICROP	60/75/80	$\varnothing 300$ mm ridger discs (Central elements)	MODB30	536 € / SET
MULTICROP	60/75/80	$\varnothing 300$ mm ridger discs (Pair of side elements)	MODB30L	647 € / SET
 $\varnothing 300$ mm Ridger discs only ( Without hub ) - MOZ010 - 48,17 € / Unit				

### Element mounting with $\varnothing 350$ mm discs

Possible mounting :	Possible inter-row spacings	Designation	Part Ref	Price € / SET
MULTICROP (Offset mounting)	45/50/60	$\varnothing 350$ mm ridger discs (Central elements)	MODB35T	555 € / SET
MULTICROP (Offset mounting)	45/50/60	$\varnothing 350$ mm ridger discs (Pair of side elements)	MODB35TL	669 € / SET
MULTICROP	75/80	$\varnothing 350$ mm ridger discs (Central elements)	MODB35	554 € / SET
MULTICROP	75/80	$\varnothing 350$ mm ridger discs (Pair of side elements)	MODB35L	668 € / SET
 $\varnothing 350$ mm Ridger discs only ( Without hub ) - MOZ035 - 50,39 € / Unit				

### Element mounting with $\varnothing 400$ mm discs

Possible mounting :	Possible inter-row spacings	Designation	Part Ref	Price € / SET
MULTICROP (Offset mounting)	45/50/60	$\varnothing 400$ mm ridger discs (Central elements)	MODB40T	570 € / SET
MULTICROP (Offset mounting)	45/50/60	$\varnothing 400$ mm ridger discs (Pair of side elements)	MODB40TL	689 € / SET
MULTICROP	75/80	$\varnothing 400$ mm ridger discs (Central elements)	MODB40	568 € / SET
MULTICROP	75/80	$\varnothing 400$ mm ridger discs (Pair of side elements)	MODB40L	688 € / SET
 $\varnothing 400$ mm Ridger discs only ( Without hub ) - MOZ036 - 52,61 € / Unit				

 Tools bracket included

 If fitting with shields: provide sheet metal extension set



Rotative weeder on element

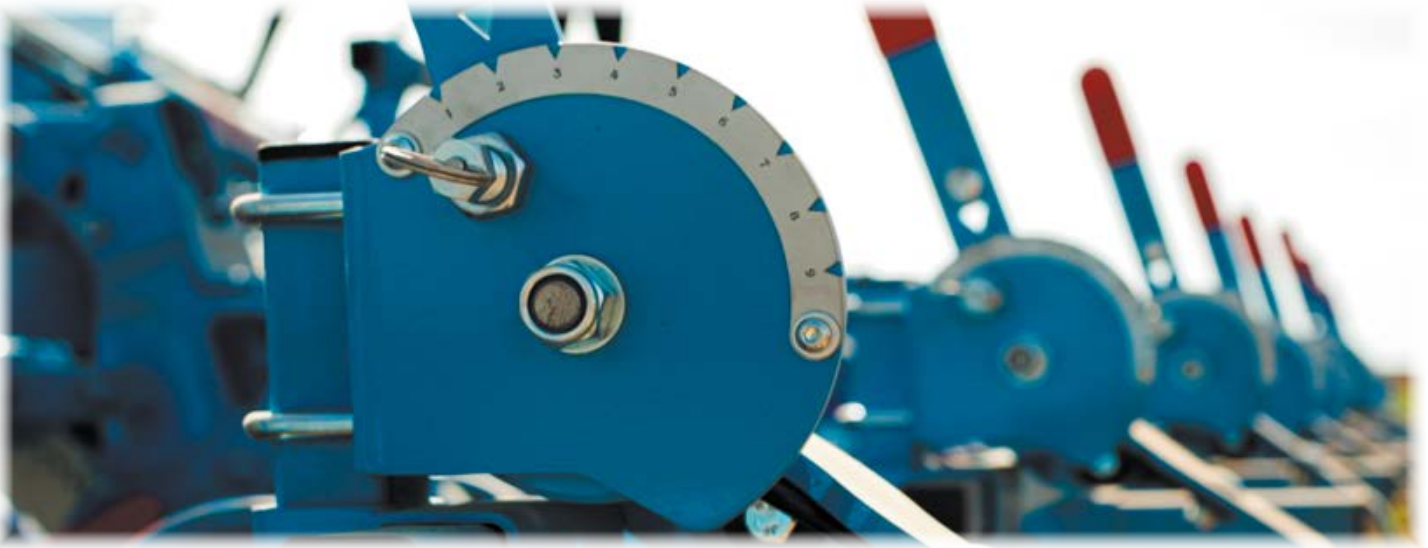

**CHARACTERISTICS :**

- Early stage use
- Uprooting weeds in the row
- Remove the crust from the area not worked by the tines.

Rotative weeder on element				
Possible mounting :	Possible inter-row spacings	Designation	Part Ref	Price € / SET
MULTICROP	45/50	Rotative weeder on element with short crossbar	MORE1	521 €
MULTICROP	60/75/80	Rotative weeder on element with long crossbar	MORE2	522 €

 Tools bracket included

 In combination with the weeder tine, provide rear off-set MOMB058

**EXAMPLE :**

6 row corn cultivator, hydraulic folding, rear mounting 75 cm = 6 x MORE



Before Rotative weeder passes After Rotative weeder passes



Weeder tines on element

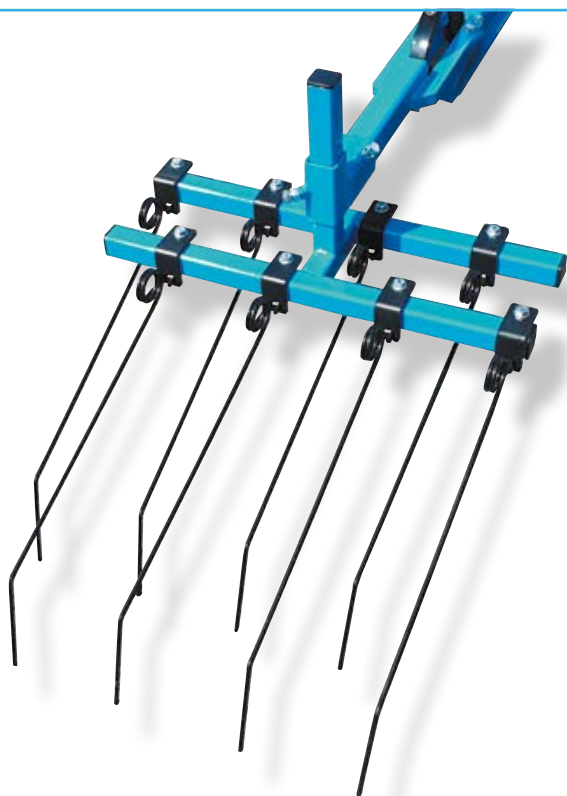

Possible mounting :	Possible inter-row spacings	Designation	Part Ref	Price € / SET
MULTICROP	30	30 Weeder tines (Central elements)	MOHE30	254 € / SET
MULTICROP	30	30 Weeder tines (Pair of side elements)	MOHE30L	362 € / SET
MULTICROP	35	35 Weeder tines (Central elements)	MOHE35	258 € / SET
MULTICROP	35	35 Weeder tines (Pair of side elements)	MOHE35L	365 € / SET
MULTICROP	40	40 Weeder tines (Central elements)	MOHE40	261 € / SET
MULTICROP	40	40 Weeder tines (Pair of side elements)	MOHE40L	368 € / SET
MULTICROP	45	45 Weeder tines (Central elements)	MOHE45	272 € / SET
MULTICROP	45	45 Weeder tines (Pair of side elements)	MOHE45L	383 € / SET
MULTICROP	50	50 Weeder tines (Central elements)	MOHE50	276 € / SET
MULTICROP	50	50 Weeder tines (Pair of side elements)	MOHE50L	387 € / SET
MULTICROP	60	60 Weeder tines (Central elements)	MOHE60	285 € / SET
MULTICROP	60	60 Weeder tines (Pair of side elements)	MOHE60L	395 € / SET
MULTICROP	75	75 Weeder tines (Central elements)	MOHE75	292 € / SET
MULTICROP	75	75 Weeder tines (Pair of side elements)	MOHE75L	403 € / SET
MULTICROP	80	80 Weeder tines (Central elements)	MOHE80	296 € / SET
MULTICROP	80	80 Weeder tines (Pair of side elements)	MOHE80L	407 € / SET
MULTICROP	90	90 Weeder tines (Central elements)	MOHE90	304 € / SET

 Tools bracket included

**EXAMPLE :**  
6 row corn cultivator, hydraulic folding,  
rear mounting 75 cm = 5 x MOHE75 + 1x MOHE75L



## Cultivator tines

### REINFORCED FLEXIBLE TINE

Reinforced flexible tine			
Possible mounting :	Designation	Ref. piece	Price H.T. €
MULTICROP / SCD	Reinforced flexible tine with <b>105 mm</b> share	MODFR105	<b>47,99 € / piece</b>
MULTICROP / SCD	Reinforced flexible tine with <b>150 mm</b> share	MODFR150	<b>47,99 € / piece</b>
MULTICROP / SCD	Reinforced flexible tine with <b>175 mm</b> share	MODFR175	<b>47,99 € / piece</b>



### FLEXIBLE BRACKET + 90° BENT BLADE EXTRA FLAT

Flexible bracket + 90° bent blade extra flat			
Possible mounting :	Designation	Ref. piece	Price H.T. €
MULTICROP / SCD	40x12 Flexible bracket + accessories (without tools)	MOZ041	<b>48,17 € / piece</b>
MULTICROP / SCD	Pair of Extra Flat 90° Blade <b>120 mm</b> without flexible bracket	MOLP12	<b>103,00 € / pair</b>
MULTICROP / SCD	Pair of Extra Flat 90° Blade <b>160 mm</b> without flexible bracket	MOLP16	<b>108,93 € / pair</b>
MULTICROP / SCD	Pair of Extra Flat 90° Blade <b>200 mm</b> without flexible bracket	MOLP20	<b>114,11 € / pair</b>

Flexible bracket



**EXAMPLE :** 3 row cultivator : 6 x MOZ041 + 3 x MOLP16

### FLEXIBLE BRACKET + EXTRA FLAT SHARE

Extra flat share			
Possible mounting :	Designation	Ref. piece	
MULTICROP / SCD	40x12 Flexible bracket + accessories (without tools)	MOZ041	<b>48,17 € / piece</b>
MULTICROP / SCD	Extra flat share 80 mm width	MOCP08	<b>42,98 € / piece</b>
MULTICROP / SCD	Extra flat share 100 mm width	MOCP10	<b>43,72 € / piece</b>
MULTICROP / SCD	Extra flat share 120 mm width	MOCP12	<b>45,20 € / piece</b>
MULTICROP / SCD	Extra flat share 140 mm width	MOCP14	<b>46,68 € / piece</b>
MULTICROP / SCD	Extra flat share 160 mm width	MOCP16	<b>48,17 € / piece</b>
MULTICROP / SCD	Extra flat share 180 mm width	MOCP18	<b>49,65 € / piece</b>
MULTICROP / SCD	Extra flat share 200 mm width	MOCP20	<b>51,13 € / piece</b>
MULTICROP / SCD	Extra flat share 240 mm width	MOCP24	<b>52,61 € / piece</b>
MULTICROP / SCD	Extra flat share 280 mm width	MOCP28	<b>54,09 € / piece</b>
MULTICROP / SCD	Extra flat share 320 mm width	MOCP32	<b>55,58 € / piece</b>
MULTICROP / SCD	Extra flat share 360 mm width	MOCP36	<b>58,54 € / piece</b>

Flexible bracket





Special tines spare parts

Designation	Ref. piece	Price €
Extra flat share 80 mm width to weld	MOCP08.S	20,15 €
Extra flat share 100 mm width to weld	MOCPS10.S	20,48 €
Extra flat share 120 mm width to weld	MOCPS12.S	20,80 €
Extra flat share 140 mm width to weld	MOCPS14.S	21,13 €
Extra flat share 160 mm width to weld	MOCPS16.S	21,45 €
Extra flat share 180 mm width to weld	MOCPS18.S	22,10 €
Extra flat share 200 mm width to weld	MOCPS20.S	22,75 €
Extra flat share 240 mm width to weld	MOCPS24.S	38,35 €
Extra flat share 280 mm width to weld	MOCPS28.S	44,20 €
Extra flat share 320 mm width to weld	MOCPS32.S	49,40 €
Extra flat share 360 mm width to weld	MOCPS36.S	52,00 €
Notched bracket to weld for extra flat share	MOCP001	13,65 €
Reinforced flexible tine only	MODFR002	40,30 €
Counter flange with screws for reinforced flexible tine	MODFR001	5,20 €
105 mm share with screws	MODFR003	5,54 €
150 mm share with screws	MODFR004	5,80 €
175 mm share with screws	MODFR005	8,46 €
Share bolt for reinforced flexible tine	MODFR006	0,99 €
40x12 flexible support only	MOZ043	41,60 €
Counter flange with screws for 40x12 flexible support for central tine without ears	MOZ044	5,64 €
Counter flange with screws for flexible support 40x12 for tine on crossbar with ears	MOZ045	6,06 €
Half coin with screws	MOZ046	5,82 €
Straight notched bracket for extra flat 90° blade without rivets	MOLP001	13,65 €
Right offset notched bracket for extra flat 90° blade without rivets	MOLP002	18,20 €
Left offset notched bracket for extra flat 90° blade without rivets	MOLP003	18,20 €
Left extra flat 90° blade 120mm wide with rivets	MOLP12.G	11,84 €
Right extra flat 90° blade 120mm wide with rivets	MOLP12.D	11,84 €
Left extra flat 90° blade 160mm wide with rivets	MOLP16.G	15,01 €
Right extra flat 90° blade 160mm wide with rivets	MOLP16.D	15,01 €
Left extra flat 90° blade 200mm wide with rivets	MOLP20.G	20,48 €
Right extra flat 90° blade 200mm wide with rivets	MOLP20.D	20,48 €

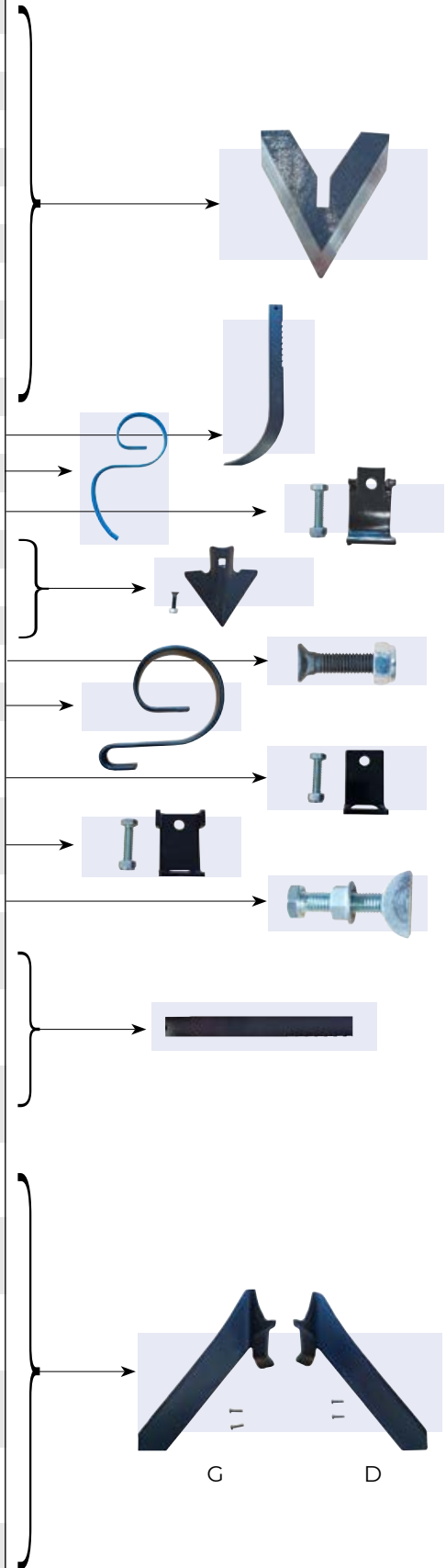



## Adjustable crop protection

### ADJUSTABLE CROP PROTECTION SET



#### Height adjustment with steps for crop protection discs

Possible mounting :	Designation	Part Ref	Price € / SET
SCD and MULTICROP	Adjustable set for crop protection discs	MOPPR	<b>104 €</b>



### ADJUSTABLE CROP PROTECTION SHIELDS

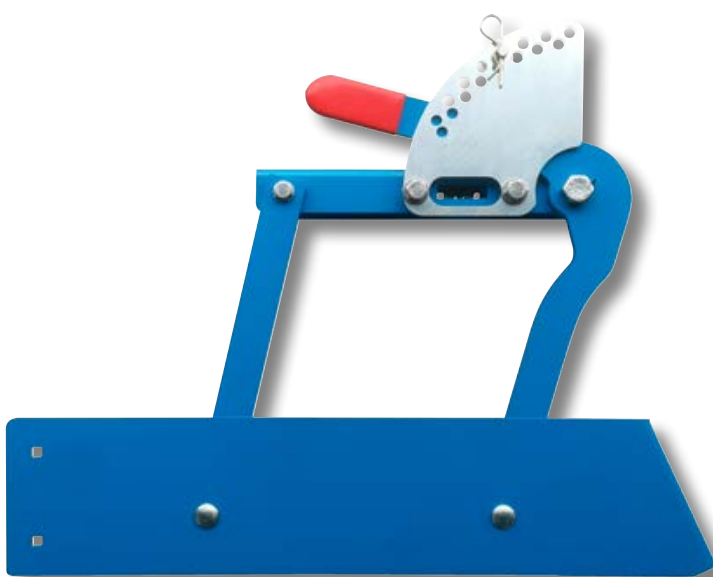

#### Adjustable crop protection shield

Possible mounting :	Minimum row spacing	Designation	Part Ref	Price € / SET
MULTICROP / SCD	45 cm (1) 35 cm (2)	Adjustable crop protection plates (The Pair)	MOPPRT	<b>208 €</b>

(1) Minimum row spacing 45 cm in 3 flexible tines configuration with 150 mm share

(2) Minimum row spacing 35 cm in 1 tine configuration



crop protection shields



## Spare parts for crop protection

Designation	Ref. piece	Price €
Shoulder axle + Beta pin Ø 3 mm MOPPR	MOPPR001	<b>4,42 €</b>
Shoulder axle + Beta pin Ø 3 mm MOPPRT	MOPPRT001	<b>7,35 €</b>
Extension shields for arable farmer	MODP15	<b>42,24 €</b>
Extension shields for market gardening	MODP19	<b>46,68 €</b>

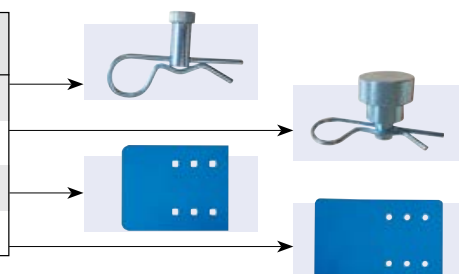

## FIXED PRECUT DISKS

Possible mounting :	Minimum row spacing	Designation	Part Ref	Price H.T. €
MULTICROP / SCD	25 cm <sup>(1)</sup> 35 cm <sup>(2)</sup>	Fixed precut disks	MODP16	231 €

(1) For MULTICROP Compact element

(2) For SCD or MULTICROP STD element



## FLEXIBLE PRECUT DISKS

Possible mounting :	Minimum row spacing	Designation	Part Ref	Price H.T. €
MULTICROP / SCD	30 cm <sup>(3)</sup> 40 cm <sup>(4)</sup>	Flexible precut disks only for crossbar mounting (the pair)	MODP17	242 €
MULTICROP / SCD	45 cm <sup>(5)</sup> 35 cm <sup>(6)</sup>	Flexible precut disks in addition to crop protection shield (the pair)	MODP11	250 €
MULTICROP / SCD	30 cm	90° sleepers (the pair)	MOT930	40,76 €
MULTICROP / SCD	45/50 cm	90° sleepers (the pair)	MOT950	46,68 €
MULTICROP / SCD	75/80 cm	90° sleepers (the pair)	MOT975	49,65 €

(3) For MULTICROP Compact element in 1 tine configuration

(4) For SCD or MULTICROP STD element in 1 tine configuration

(5) Minimum row spacing 45 cm in 3 flexible tines configuration with 150 mm share

(6) Minimum row spacing 35 cm in 1 tine configuration

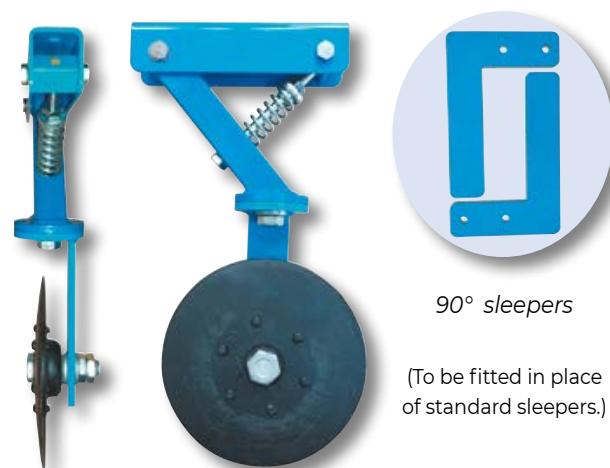

90° sleepers

(To be fitted in place of standard sleepers.)



Vegetable interface for camera guidance



**SPECIAL**

## FIXED VEGETABLES GUIDANCE

On a self-guided frame basis, the distance from the hoeing machine at the rear is necessary to allow the camera to detect the plants between the tractor and the hoeing machine.

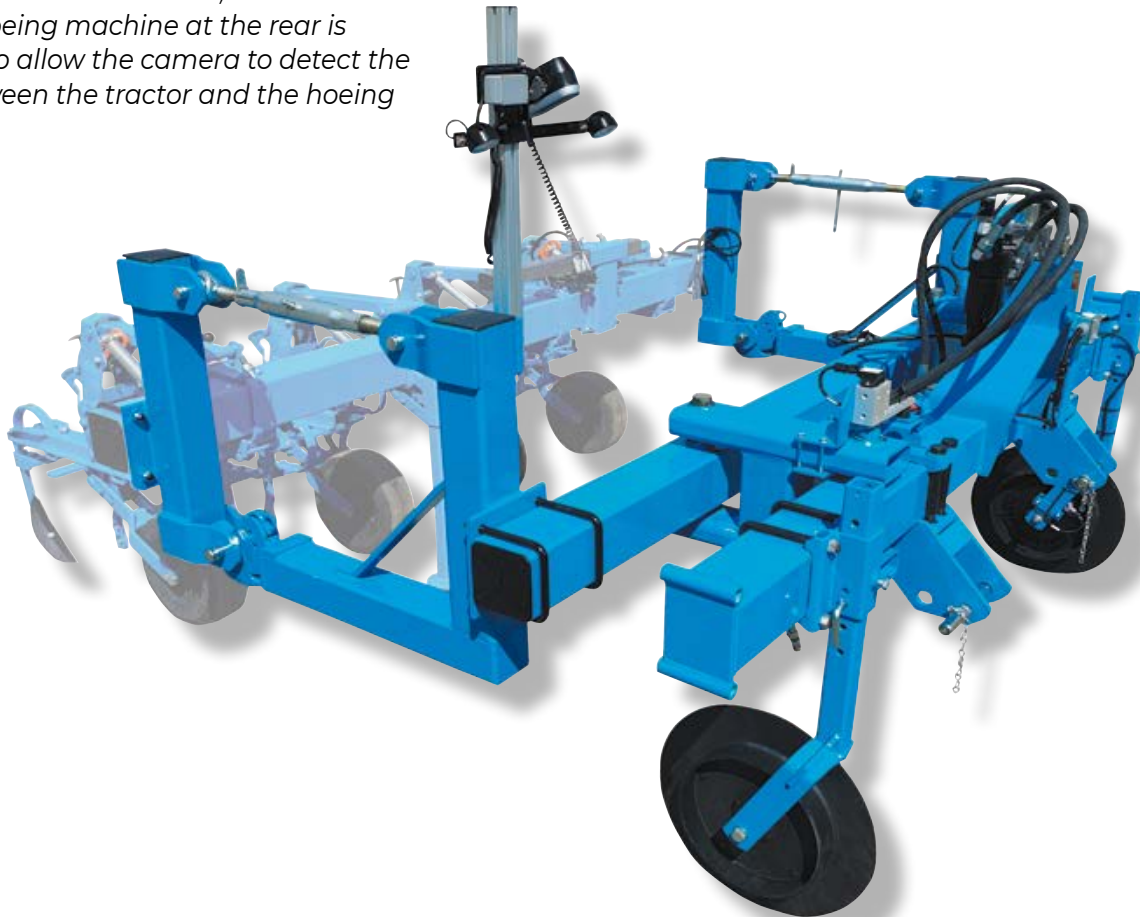

Bare vegetable interface (without camera / without hydraulic block) see pages 22-23			
Possible mounting :	Designation	Ref. piece	Price € / SET
Self-guided cultivator *	Fixed vegetables guidance interface	MOIMF	5 509 €
Self-guided cultivator *	Unmountable vegetables guidance interface	MOIMD	6 452 €
Unmountable vegetables interface	Fixing bracket (the pair)	MOIMC	462 €
	Harness + additional brackets	MOKC2	731 €



Fixed market garden interface

Requires cultivator without hitch / without coulter

Arable farming interface for camera guidance

**SPECIAL FOR ARABLE FARMING**



## CHARACTERISTICS

- Hitch (Tractor side) : CAT 3
- Hitch (Cultivator side) : CAT 2/3
- Travel stroke : 500 mm
- Reduced offset : 370 mm
- Weight : 712 kg

### Bare arable farming interface (without camera / without hydraulic block)

Possible mounting :	Designation	Ref. piece	Price € / SET
Self-guided cultivator from 3,50 m - 5 m	2 coulters interface <sup>(1)</sup>	MOINT2	6 577 €
Self-guided cultivator from 5 m - 7 m	2 coulters interface <sup>(1)</sup>	MOINT2R	7 661 €
Self-guided cultivator > 8 m	4 coulters interface <sup>(2)</sup>	MOINT4	9404 €

### Arable farming interface + 3D camera system

Possible mounting :	Designation	Ref. piece	Price € / SET
Self-guided cultivator from 3,50 m - 5 m	2 coulters 3D camera interface <sup>(1)</sup>	MOINT2KC	24 078 €
Self-guided cultivator from 5 m - 7 m	2 coulters 3D camera interface <sup>(1)</sup>	MOINT2RKC	25 161 €
Self-guided cultivator > 8 m	4 coulters 3D camera interface <sup>(2)</sup>	MOINT4KC	26 904 €
Harness + additional brackets		MOKC2	731 €
Added value 2nd 3D camera <sup>(3)</sup>		MOKC4	8 733 €

### Arable farming interface + colorimetric camera system

Possible mounting :	Designation	Ref. piece	Price € / SET
Self-guided cultivator from 3,50 m - 5 m	2 coulters colorimetric camera interface <sup>(1)</sup>	MOINT2KT	24 059 €
Self-guided cultivator from 5 m - 7 m	2 coulters colorimetric camera interface <sup>(1)</sup>	MOINT2RKT	25 142 €
Self-guided cultivator > 8 m	4 coulters colorimetric camera interface <sup>(2)</sup>	MOINT4KT	26 885 €
Harness + additional brackets		MOKT2	730 €
Added value 2nd colorimetric camera <sup>(3)</sup>		MOKT4	3 569 €



CAT 2/3 hitch

- (1) Track widths from 1690 to 2400 mm possible  
 (2) Manual folding for 3 m road width  
 (3) Including harness, brackets, camera and headlights



3D camera guidance system on self-steering frame

Adaptable 3D camera guidance system		
Designation	Part Ref	Price € / SET
3D camera system with integrated headlights	MOKC3	<b>17 967 €</b>
Added value row feelers <sup>(1) (2)</sup>	MOKP	<b>1 401 €</b>
Added value joystick for manual control	MOKJC	<b>242 €</b>
Harness + additional brackets	MOKC2	<b>731 €</b>
Added value 2nd colorimetric camera <sup>(3) (4)</sup>	MOKC4	<b>8 733 €</b>
Less value main camera headlights	MOKC5	<b>-1 165 €</b>
Less value second camera headlights	MOKC6	<b>-716 €</b>

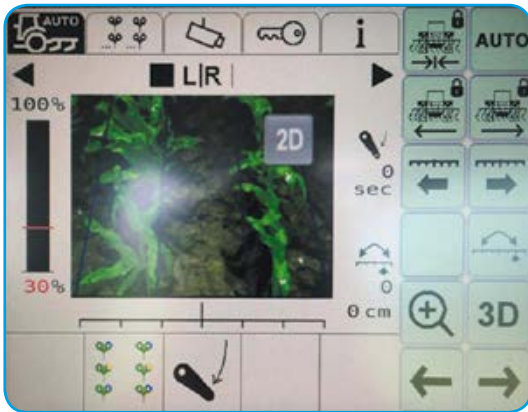

- (1) Row spacing 45 to 80 cm
- (2) Fitted to MULTICROP element
- (3) Including harness, brackets, camera and headlights
- (4) For hoeing machines with double camera, it may be necessary to dismantle the camera for folding into transport position



## CAMERA SET DESIGNATION

- Detection optics on adjustable pole,
- Piloting ECU,
- Setting terminal + control display,
- Hydraulic system,
- Working lights.
- Radar plug in standard



## Spare parts

Designation	Ref. piece	Price €
3D camera spiral cord	MOKC7	<b>180,54 €</b>
3D camera and headlights extension cable 4 m	MOKC8	<b>128,13 €</b>
Sensor extension cable 2,50 m	MOKC9	<b>62,61 €</b>
Speed sensor	MOKC10	<b>61,15 €</b>
3rd point sensor	MOKC11	<b>180,54 €</b>
3D camera tractor harness	MOKC12	<b>369,82 €</b>
3D camera machine harness	MOKC13	<b>547,46 €</b>

## Colorimetric camera guidance system on self-steering frame

Adaptable colorimetric camera guidance system		
Designation	Part Ref	Price € / SET
Colorimetric camera system with integrated headlights	MOKT3	<b>17 948 €</b>
Added value row feelers <sup>(1)</sup> <sup>(2)</sup>	MOKTP	<b>1555 €</b>
Harness + additional brackets	MOKT2	<b>730 €</b>
Added value 2nd colorimetric camera <sup>(3)</sup> <sup>(4)</sup>	MOKT4	<b>3 569 €</b>
Added value colorimetric camera for 2nd independent section	MOKT5	<b>10 595 €</b>
Less value main camera headlights	MOKT6	<b>-377 €</b>
Less value second camera headlights	MOKT7	<b>-376 €</b>



- (1) Row spacing 45 to 80 cm
- (2) Fitted to MULTICROP element
- (3) Including harness, brackets, camera and headlights
- (4) For hoeing machines with double camera, it may be necessary to dismantle the camera for folding into transport position



## Spare parts

Designation	Ref. piece	Price €
Colorimetric camera beam 5 m	MOKT8	<b>206,70 €</b>
Colorimetric camera harness connection box 1.50 m	MOKT9	<b>219,70 €</b>
6 m terminal harness	MOKT10	<b>318,50 €</b>



## MANUAL HYDRAULIC GUIDANCE

Manual hydraulic system		
Designation	Part Ref	Price € / SET
Comfort seat + belt with mechanical suspension for joystick guidance (127x127 beam mounting)	MOSB	<b>775 €</b>
Hydraulic block + joystick + row feelers	MOKB2	<b>3 398 €</b>
Hydraulic block + joystick	MOKB1	<b>2 687 €</b>





Switch box system

## HYDRAULIC ELEMENTS LIFT WITH SWITCH BOX

Hydraulic elements lift with Switch box							
Possible mounting	Row number	Element number	Designation	Kit without cylinders <sup>(1)</sup>		Kit with cylinders	
				Part Ref	Price € / SET	Part Ref	Price € / SET
<b>MULTICROP</b>	4	5	Element lifting kit 4 rows manual	MORM4	<b>3 745 €</b>	MORM4V	<b>4 574€</b>
	5	6	Element lifting kit 5 rows manual	MORM5	<b>4 681 €</b>	MORM5V	<b>5 675 €</b>
	6	7	Element lifting kit 6 rows manual	MORM6	<b>5 617 €</b>	MORM6V	<b>6 777 €</b>
	7	8	Element lifting kit 7 rows manual	MORM7	<b>6 177 €</b>	MORM7V	<b>7 503 €</b>
	8	9	Element lifting kit 8 rows manual	MORM8	<b>6 625 €</b>	MORM8V	<b>8 116 €</b>
	9	10	Element lifting kit 9 rows manual	MORM9	<b>7 348 €</b>	MORM9V	<b>9 004 €</b>
	11	12	Element lifting kit 11 rows manual	MORM11	<b>8 274 €</b>	MORM11V	<b>10 263 €</b>
	12	13	Element lifting kit 12 rows manual	MORM12	<b>9 315 €</b>	MORM12V	<b>11 470 €</b>
			Added value LS	MOLS	<b>623 €</b>	MOLS	<b>623 €</b>
 (1) Please add cylinders to the quote - REF 64040011 : <b>230,15 € / cylinder</b>							

Example switch box for 8 rows cultivator



Example of 4-row cultivator assembly

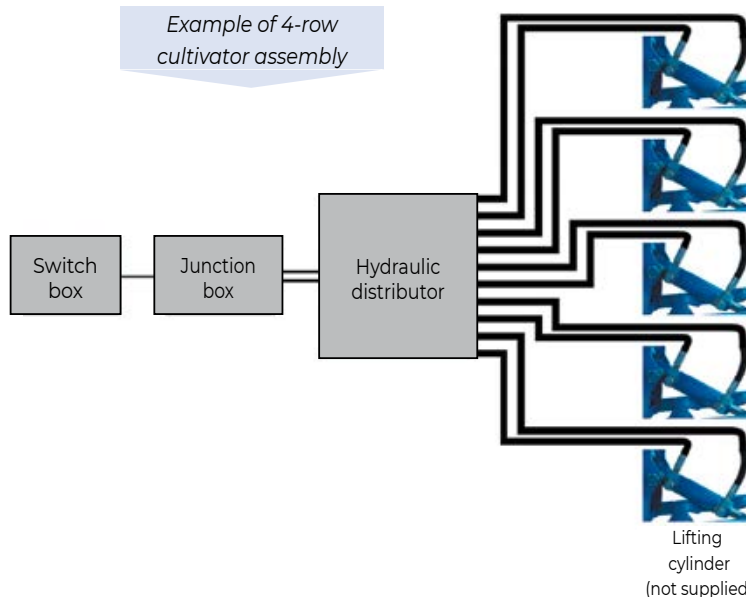

### CHARACTERISTICS

- Hydraulic(s) bloc(s)
- Hydraulic hoses
- Hydraulic flow regulator
- Connecting box
- Tractor harness
- Switch box



 Incompatible with SCD elements

## ISO HYDRAULIC ELEMENTS LIFT



ISO Terminal :

**Manual control**



Supplied without terminal

**2 choices available**

**OR**

Unlocked ISO terminal Section Control :

**GPS autopilot**



Terminal / Section control licences : not supplied

### Element lifting system with GPS-ISO management (without terminal)

Possible mounting :	Row number	Element number	Designation	Kit without cylinders <sup>(1)</sup>		Kit with cylinders	
				Part Ref	Price € / SET	Part Ref	Price € / SET
<b>MULTICROP</b>	4	5	Element lifting kit 4 rows GPS controlled	MORSC4	<b>4 737 €</b>	MORSC4	<b>5 638 €</b>
	5	6	Element lifting kit 5 rows GPS controlled	MORSC5	<b>5 921 €</b>	MORSC5	<b>6 916 €</b>
	6	7	Element lifting kit 6 rows GPS controlled	MORSC6	<b>7 104 €</b>	MORSC6	<b>8 264 €</b>
	7	8	Element lifting kit 7 rows GPS controlled	MORSC7	<b>7 502 €</b>	MORSC7	<b>8 828 €</b>
	8	9	Element lifting kit 8 rows GPS controlled	MORSC8	<b>7 890 €</b>	MORSC8	<b>9 381 €</b>
	9	10	Element lifting kit 9 rows GPS controlled	MORSC9	<b>10 887 €</b>	MORSC9	<b>12 544 €</b>
	11	12	Element lifting kit 11 rows GPS controlled	MORSC11	<b>11 760 €</b>	MORSC11	<b>13 748 €</b>
	12	13	Element lifting kit 12 rows GPS controlled	MORSC12	<b>12 667 €</b>	MORSC12	<b>14 822 €</b>
	18	19	Element lifting kit 18 rows GPS controlled	MORSC18	<b>15 611 €</b>	MORSC18	<b>18 760 €</b>
			Added value LS	MOLS	<b>623 €</b>	MOLS	<b>623 €</b>

(1) Please add cylinders to the quote - REF 64040011 : **230,15 € / Cylinder**

## CHARACTERISTICS

- Hydraulic(s) bloc(s)
- Hydraulic hoses
- Hydraulic flow regulator
- Filtration system
- Connecting box
- Connection cable with ISO Socket
- Piloting ECU



Example of 18-row cultivator assembly

Incompatible with SCD elements



ACCESSORIES

## DPAE ELECTRIC DRIVE FOR FERTILIZER

### TECHNICAL FEATURES

- DPAE electric drive kit for 1 to 3 outlet fertilizers (without screen) including :
- Access to the mobile application\* for working and calibration
- Motor + Ø 16 mm drive shaft
- Mounting bracket
- Power supply cable with 3-pin plug



#### 1 MOTOR KIT

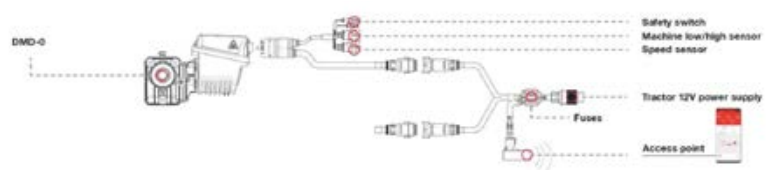

#### 2 MOTORS KIT

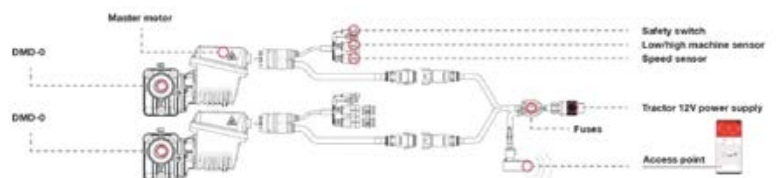

Dual motor kit : able to manage 2 doses and 2 seeding density



Minimum speed : 0,7 Km/h with GPS antenna

Designation	Ref. piece	Price €
1 Motor Kit	MOFE1	<b>1 898 €</b>
2 Motors Kit	MOFE2	<b>2 609 €</b>
Options		
3rd point cut-off sensor	MOFE3	<b>110,16 €</b>
GPS antenna + cable	MOFE4	<b>260,64 €</b>
7-pin cable (speed info / 3rd point cut-off)	MOFE5	<b>67,68 €</b>



\* Can be used with IOS and Android equipped with Wi-fi



# FELCROP

DÉSHÉBAGE DE PRÉCISION

ZA Les Pelletiers  
89100 SOUCY  
France

✉ [contact@feelcrop.com](mailto:contact@feelcrop.com)

☎ +33 (0)3 86 66 47 22

